



ADVANCED MANUAL

UHF TRANSCEIVER
IC-41PRO

IMPORTANT

READ ALL INSTRUCTIONS carefully before using the IC-41PRO UHF TRANSCEIVER.

KEEP THIS ADVANCED MANUAL, as it contains important operating information that may be useful in the future.

The **BASIC MANUAL** is supplied with the transceiver.

This ADVANCED MANUAL describes the radio as supplied in standard factory default setting. However, the settings on your transceiver may differ if it has been customised by your dealer. For details, refer to your authorised Icom dealer or the administrator for your organisations radios.

TABLE OF CONTENTS

IMPORTANT.....	i	4. SCAN.....	8-10
TABLE OF CONTENTS.....	i	Scan types.....	8
1. BASIC OPERATION.....	1-2	Scanning preparation.....	8
PWR ON Password.....	1	◇ Selecting a scan type.....	8
Keylock.....	1	◇ Setting a Tag channel.....	8
◇ Non-locked keys.....	1	◇ Setting the Scan Stop Timer.....	9
Channel selection.....	1	Open scan.....	9
Zone selection.....	2	Group and Priority scan.....	9
Priority channel.....	2	Repeater scan.....	10
◇ Setting the Priority channel.....	2	◇ Repeater scan flow.....	10
◇ Switching to the Priority channel.....	2	5. TONE SQUELCH AND POCKET BEEP.....	11-12
◇ Cancelling the Priority channel.....	2	Tone Squelch.....	11
Monitor.....	2	◇ Setting the	
Squelch.....	2	CTCSS tone frequency/DTCS code.....	11
2. SET MODE.....	3-6	◇ Turning ON the Tone Squelch.....	11
◇ Set mode sequence.....	3	Pocket Beep.....	12
◇ Backlight.....	4	◇ Waiting for a call from a station.....	12
◇ Beep.....	4	6. SELCALL (Selective calling).....	13-14
◇ Beep Level.....	4	Calling.....	13
◇ Channel Announce.....	4	◇ Selecting a TX code.....	13
◇ CTCSS/DTCS.....	4	◇ Editing the TX code.....	13
◇ VOX.....	4	◇ Transmitting an individual Selcall.....	13
◇ VOX Gain.....	4	Receiving.....	14
◇ VOX Delay (Sec).....	4	◇ Receiving an individual Selcall.....	14
◇ Roger Beep.....	5	◇ Recalling a memorised RX code.....	14
◇ Ringer Level.....	5	◇ Receiving a Group call.....	14
◇ Squelch Level.....	5	Quiet Mode.....	14
◇ Mic Gain.....	5	Stun function.....	14
◇ Battery Voltage.....	5	7. OTHER FUNCTIONS.....	15-16
◇ Signal Monitor.....	5	Smart Ring and ATS (Automatic Transponder System).....	15
◇ Auto Power OFF.....	5	◇ Smart Ring.....	15
◇ Power Save.....	5	◇ ATS.....	15
◇ Lockout.....	6	RX channels and frequencies.....	15
◇ Scan Stop Timer.....	6	◇ Editing an RX frequency.....	15
◇ Scan Restart.....	6	PTT Hold.....	16
◇ PTT Hold.....	6	Data cloning.....	16
◇ Own ID.....	6	8. SPECIFICATIONS.....	17
3. REPEATER OPERATION.....	7	◇ General.....	17
Repeater operation.....	7	◇ Transmitter.....	17
		◇ Receiver.....	17
		INDEX.....	18

Section 1 BASIC OPERATION

PWR ON Password

If the transceiver is set with a power ON password, enter the password when turning ON the transceiver. To enter the password, see the illustration below.

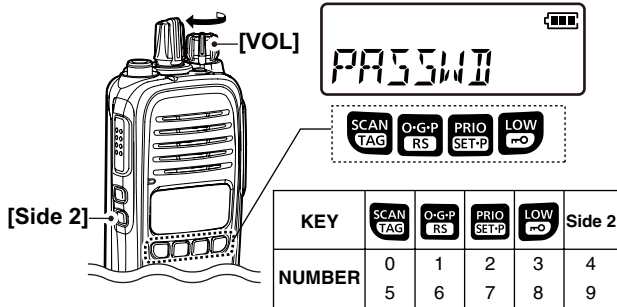

The password is a 4 digit code (example: 1234).

- Push the corresponding keys to enter your password.
 - Note that each key represents two digits. That means, “3764” and “8769” are entered in exactly the same way (requires no multiple or extended pushing.)
 - The entered password will not be displayed.
 - If “PASSWD” does not disappear after entering, the entered password is incorrect. Turn OFF the transceiver, and then try again.

Keylock

Hold down for 2 seconds to electronically lock [ROTARY SELECTOR] and all keys except [PTT], [Side 1], [TOP], (When in the Function mode) and to prevent accidental channel changing or function access.

To lock the keys:

- Hold down for 2 seconds to lock.
 - “” is displayed.

To unlock the keys:

- Hold down for 2 seconds again to unlock.
 - “” disappears.

◆ Non-locked keys

Even when the Keylock function is ON, you can use the following keys for certain conditions.

[PTT]: You can hold down to transmit, and release to receive.

[Side 1]: You can push to turn the Monitor function ON or OFF.

[TOP]: You can push to change between Normal mode and Function mode.

: In the Function mode, you can hold down for 2 seconds to transmit the selected Selcall code, when a CB channel is selected.

: You can hold down for 2 seconds to turn OFF the Keylock function.

Channel selection



There are 80 UHF CB channels and you have access to all 80 channels, including designated repeater channels. You can select between them to communicate with a specific person(s). The IC-41PRO is also capable of being set with an additional 35 receive only channels, using the optional CS-41PRO CLONING SOFTWARE.

- Rotate [ROTARY SELECTOR] to scroll through the selectable channels.

Zone selection

(Selectable only when more than 2 zones are set, using the optional CS-41PRO CLONING SOFTWARE)

A zone enables you to allocate several channels into a logical group. This is useful if you want to simplify communications, particularly in commercial or convoy applications, or if you want to separate out the receive only channels to be scanned separately from CB channels.

- ① Push [TOP] to enter the Function mode.
- ② Hold down  for 2 seconds to enter the zone selection mode.
- ③ Rotate [ROTARY SELECTOR] to select the desired zone, and then push  to set.

NOTE:

- The transceiver remains in the selected mode when turned OFF and then ON again.
- CB-05, CB-R05 and CB-35 channels are for emergency use, and are required to be left open for only emergency use. CB-22 and CB-23 are used for only receiving.

Priority channel

The Priority channel enables you to have quick access to a specific channel. Only one channel can be set as the Priority channel. "P" is displayed when the Priority channel is set.

◇ Setting the Priority channel

- ① Rotate [ROTARY SELECTOR] to select a desired channel.
- ② Hold down  for 2 seconds to set the selected channel as the Priority Channel.
 - "P" is displayed.

◇ Switching to the Priority channel

- ➔ Push  to switch from a displayed channel to the Priority channel. "N/A" is displayed when the Priority channel is not set.

◇ Cancelling the Priority channel

- ➔ Push [TOP] to enter the Function mode, and then hold down  for 2 seconds to cancel the Priority channel setting.
 - "P" disappears.

Monitor

The Monitor function opens the Squelch or Tone squelch, enabling you to receive weak signals. This enables quick access to the open squelch setting.

- ➔ To turn the Monitor function ON or OFF, push [Side 1].
 - "MONI ON" or "MONI OF" is displayed when the function is turned ON or OFF.

Squelch

In order to clearly receive signals, set the squelch level to suit your environment. This eliminates background noise when there are no signals present. A higher level is better for inner cities or noisy areas, and a lower level is more beneficial in quiet, rural or country areas.

Setting the squelch level:

- ① Push [Side 2] to enter the squelch setting mode.
- ② Rotate [ROTARY SELECTOR] to set the squelch level to between 0 and 9.
 - 0= lowest squelch level, 9= highest squelch level
- ③ Push [Side 2] to set the selected squelch level and exit the setting mode.

Information

You can also set the squelch level in the Set mode. See page 5 for details.

Section 2 SET MODE

In the Set mode, you can change various transceiver settings to suit your operating requirements.

- ① Hold down [TOP] for 2 seconds to enter the Set mode.
 - If no key is pushed for 30 seconds, the transceiver will return to the normal mode.
- ② Push [Side 1] or [Side 2] to select an item.
 - You can also select an item by pushing [TOP].
- ③ Rotate [ROTARY SELECTOR] to select an option in the selected item.
- ④ Hold down [TOP] for 2 seconds to set and exit the Set mode, or simply turn OFF the transceiver.

Own ID

Your Own ID is omitted from the Set mode sequence by default. You can set this item using the optional CS-41PRO CLONING SOFTWARE.

VOX related items

The following items are displayed in the Set mode only when the optional HM-168LWP SPEAKER MICROPHONE or other optional external device is connected to the transceiver. See the BASIC MANUAL for external device connection details.

- VOX
- VOX Gain
- VOX Delay (Sec)

◇ Set mode sequence

The diagram below describes the sequence of the items in the Set mode.

- The sequence is as shown below when you push [Side 1] in the Set mode.

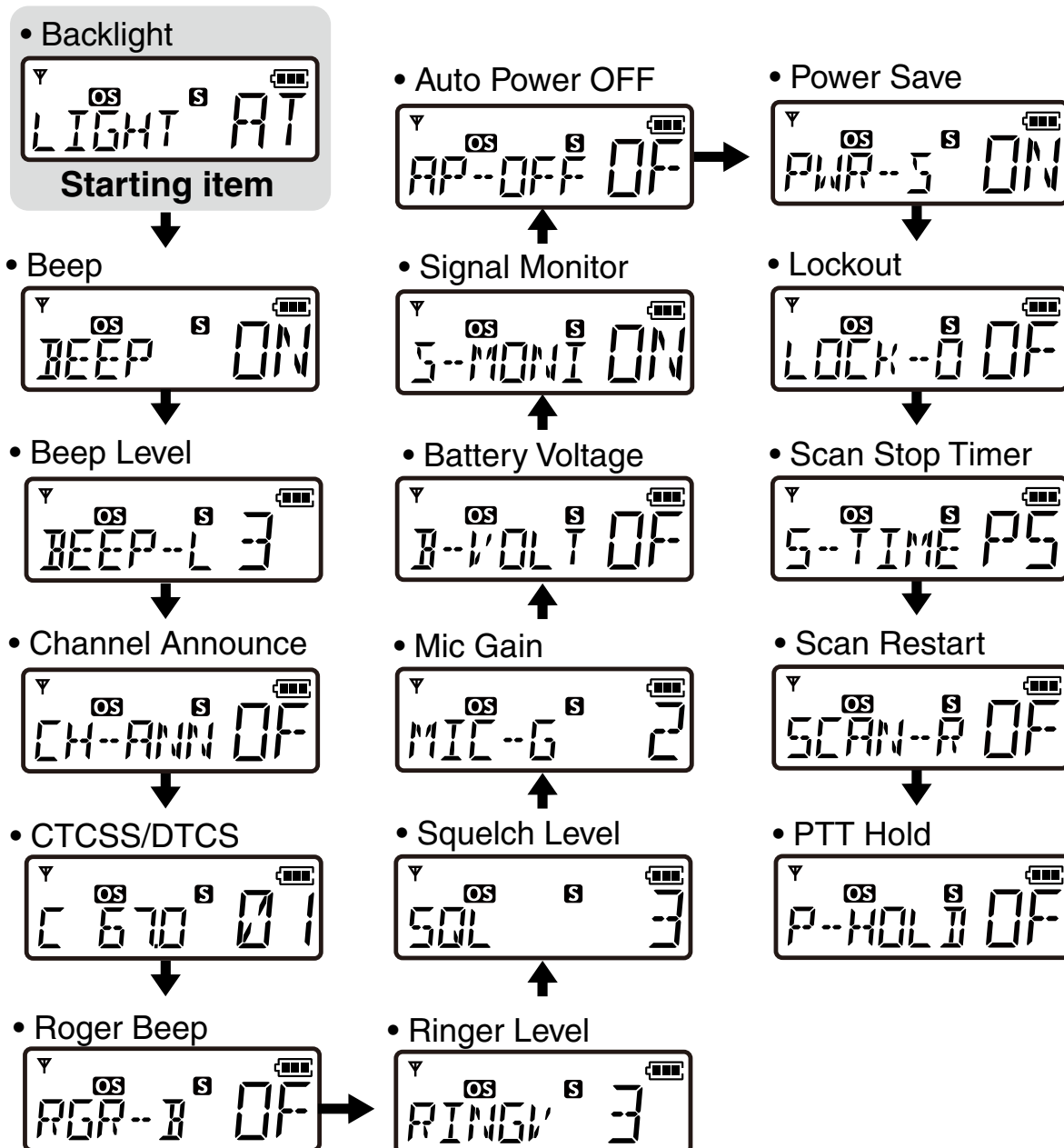

◇ **Backlight**

The transceiver features a backlit LCD display to use in low-light conditions. You can select the backlight mode in the Set mode.

- ON:** Backlight is continuously ON.
- A2:** Lights for 5 seconds when STATUS INDICATOR changes, or when you push any key except [PTT].
- AT:** Lights for 5 seconds when you transmit or receive a Selcall signal, or when you push any key except [PTT].
- OF:** No backlight.

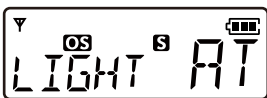

Backlight Auto (default)

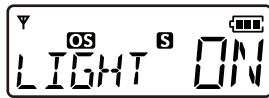

Backlight ON

◇ **Beep**

The confirmation beep is set to ON as the default. You can turn OFF the beep for silent operation in the Set mode.

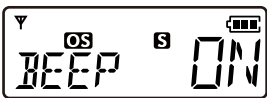

Beep ON (default)

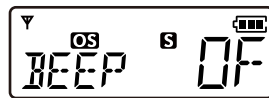

Beep OFF

◇ **Beep Level**

You can set the volume level for the key beeps to between 1 and 5, or 1(Linked) and 5(Linked). When a linked level is set, you can adjust the Beep Level by rotating [VOL].

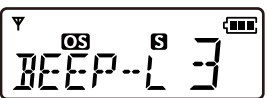

Beep level 3 (default)

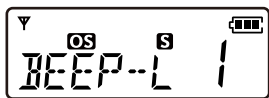

Beep level 1

◇ **Channel Announce**

You can turn this function ON to announce the selected channel number.

- When Beep is set to OFF, there will not be an announcement, regardless of this setting.

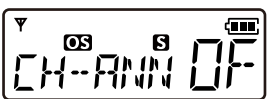

Channel Announce OFF (default)

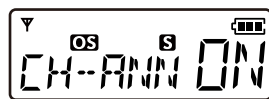

Channel Announce ON

◇ **CTCSS/DTCS**

Select the desired CTCSS tone frequency or DTCS code.

You can change between CTCSS and DTCS setting modes by pushing . See page 11 for more information about CTCSS and DTCS.

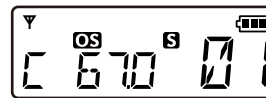

CTCSS tone frequency setting mode (default)

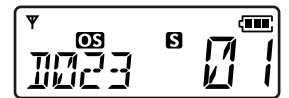

DTCS code setting mode

◇ **VOX**

(Displayed only when an optional external device is connected to the transceiver)

This function automatically switches between receiving and transmitting mode by detecting your voice.

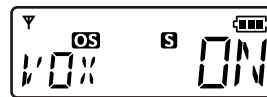

VOX function ON (default)

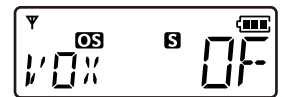

VOX function OFF

◇ **VOX Gain**

(Displayed only when an optional external device is connected to the transceiver)

Set the VOX Gain level to between 1 and 10. Higher gain makes the VOX function more sensitive to your voice.



VOX Gain level 5 (default)



VOX Gain level 8

◇ **VOX Delay (Sec)**

(Displayed only when an optional external device is connected to the transceiver)

VOX Delay is the period of time between when you stop speaking and the transceiver stops transmitting and then returns to receive. Set it to between 0.5 and 3.0 seconds.

NOTE:

If you set the time too short, a pause in speaking will be regarded as the end of your conversation and the transceiver will return to receive, even if you continue speaking.

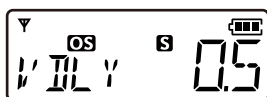

VOX Delay 0.5 seconds (default)

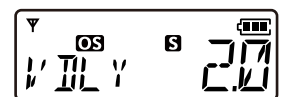

VOX Delay 2.0 seconds

◇ Roger Beep

You can turn ON the Roger Beep function to beep to indicate that the transmission has ended.

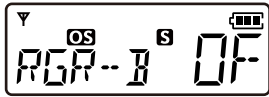

Roger Beep OFF (default)

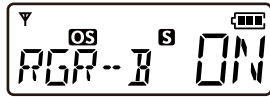

Roger Beep ON

◇ Ringer Level

You can set the Ringer Level to between 1 and 5, or 1 (Linked) and 5 (Linked).

When a linked level is set, you can adjust the Ringer Level by rotating [VOL].

NOTE: You need to set the Beep function to ON before setting the Ringer Level. (p. 4)

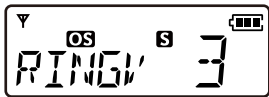

Ringer Level 3 (default)



Ringer Level 5

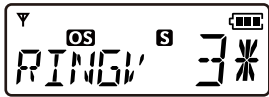

Ringer Level 3 (Linked)

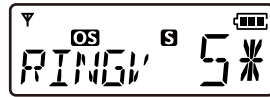

Ringer Level 5 (Linked)

◇ Squelch Level

The Squelch circuit eliminates background noise when no signals are present.

Set the level to where the noise just disappears, for proper operation.

A higher level is better for inner cities or noisy areas, and a lower level is more beneficial in quiet, rural or country areas. (0=lowest, 9=highest)

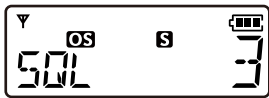

Squelch Level 3 (default)



Squelch Level 0

◇ Mic Gain

You can adjust the microphone sensitivity to between 1 (minimum sensitivity) and 4 (maximum sensitivity).

With a higher sensitivity, the microphone picks up softer voices, though it may pick up more ambient noise.

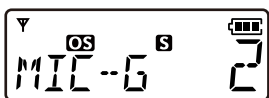

Mic Gain sensitivity 2 (default)

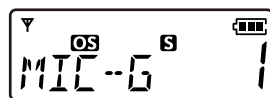

Mic Gain sensitivity 1

◇ Battery Voltage

You can set to display the Battery Voltage for 2 seconds, when you turn ON the transceiver.

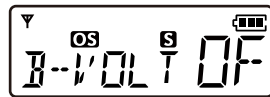

Battery Voltage OFF (default)



Battery Voltage ON

◇ Signal Monitor

You can select whether or not to mute a Selcall code signal, DTMF code signal or Roger Beep emission.

ON: Unmuted

OFF: Muted

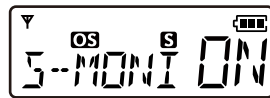

Signal Monitor ON (default)



Signal Monitor OFF

◇ Auto Power OFF

You can set the transceiver to automatically turn OFF after a set period without any key operation.

You can set it to between 0.5 and 4.0 hours (0.5 hour steps) or 8.0 hours.

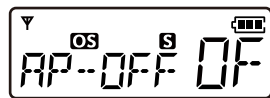

Auto Power OFF is OFF (default)

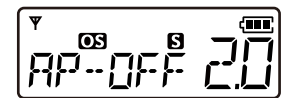

2 hour setting

◇ Power Save

The Power Save function reduces the current drain by deactivating the receiver circuit if a signal is not received, or the transceiver is not used for 5 seconds.

The receiver periodically reactivates, checks for any signals, and deactivates according to a preset timer setting.

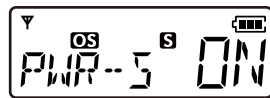

Power Save ON (default)

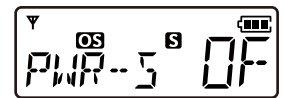

Power Save OFF

◇ **Lockout**

Select the transmission Lockout function mode which temporarily inhibits transmission.

- **RP** (Repeater Lockout): Locks out a repeater.
- **BU** (Busy Lockout): Locks out a busy channel.
- **OF** (OFF): Turns OFF the function.

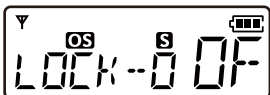

Lockout OFF (default)

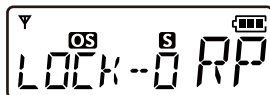

Repeater Lockout setting

◇ **Scan Stop Timer**

You can set the Scan Stop Timer to pause (P5) or timer scan (5/10/15).

When a signal disappears, the scan resumes after the set period of time. (p. 9)

5/10/15: Scan pauses for 5, 10 or 15 seconds when a signal is detected, then resumes.

P5: Scan pauses until the signal disappears, and then resumes after 5 seconds (Recommended setting).

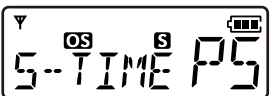

Scan Stop Timer
P5 (default)

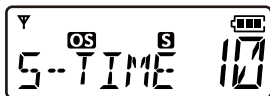

10 second setting

◇ **Scan Restart**

This function restarts the scan 10 seconds after you stop transmitting.

You can turn the function ON or OFF.



Scan Restart OFF (default)

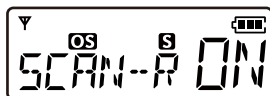

Scan Restart ON

◇ **PTT Hold**

You can use the PTT switch as a one-touch PTT switch (push once between transmit and receive).

You can transmit without holding down [PTT] using this function. Transmission automatically stops after 3 minutes in this mode.

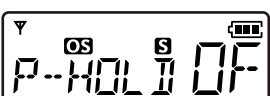

PTT Hold function
OFF (default)

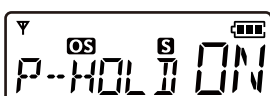

PTT Hold function ON

◇ **Own ID**

(You can only set this item after enabling the function using the optional CS-41PRO CLONING SOFTWARE.)

This function enables you to allocate your Own ID which identifies you as a target for Selcall operation and allows tracking of the origin of transmissions.

Editing your Own ID:

- ① When your Own ID is displayed, hold down for 2 seconds to enter the editing mode.

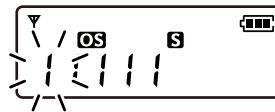

- ② Rotate [ROTARY SELECTOR] until the desired number is displayed on the blinking digit.

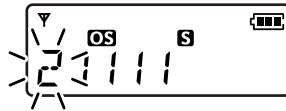

- ③ Push to set the blinking digit and go to the next digit.

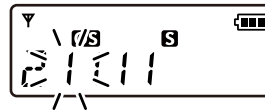

- ④ Repeat steps ② and ③ until all 5 digits are set, and then push again to save the Own ID.

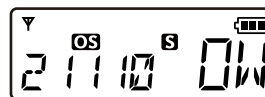

Repeater operation

Repeaters extend the operational range of the transceiver by retransmitting the signals it receives. Repeaters are usually located on the top of a building or a mountain, as the elevation increases their effectiveness, allowing the user to transmit and receive over greater distances. During Simplex operation, transceivers transmit and receive on the same frequency. During Duplex operation (using a repeater) transceivers transmit and receive on different frequencies. It automatically does this when one of the repeater channels is selected.

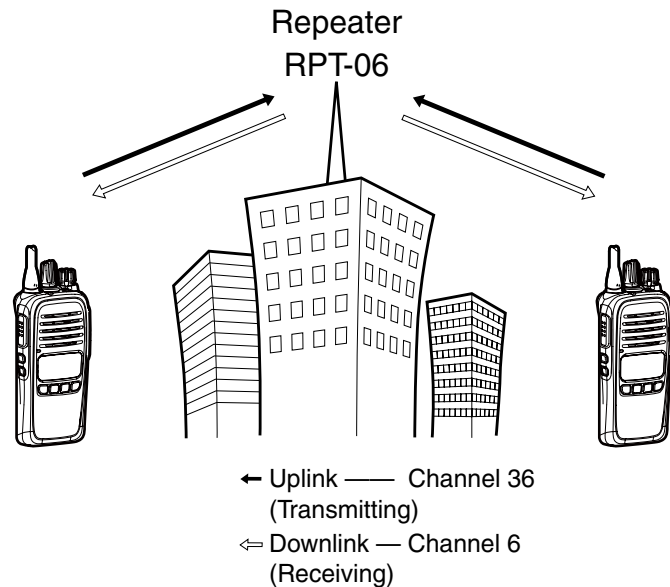

Accessing a repeater:

To use a repeater, you need to select a repeater channel (Repeater CH 1 to 8, and 41 to 48).

You can search for any accessible repeaters in your local area by using the Repeater scan. (p. 10)

- ➔ Rotate [ROTARY SELECTOR] to select a repeater channel.
 - "DUP" is displayed.

Section 4 SCAN

Scan types

The transceiver has 4 scan types, a Tag function and 4 Resume options, for scanning versatility.

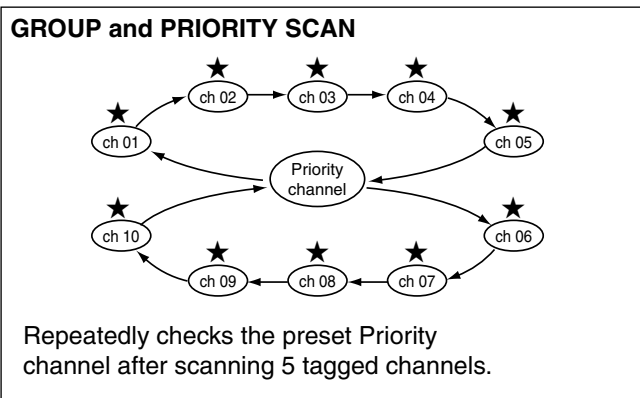
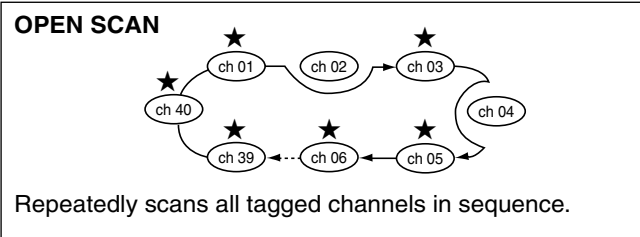

Tagged channels are independently set for Open, Group and Priority scans. All channels may be preset as tagged channels for all scans.

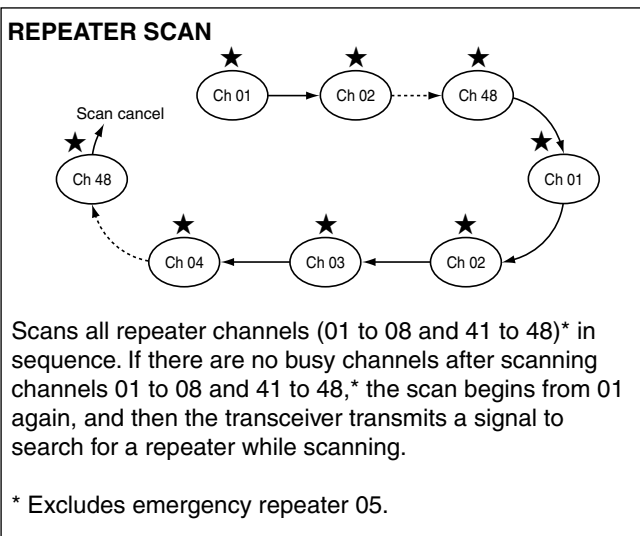

Scanning preparation

The IC-41PRO scans all tagged channels when a scan is activated. When it detects a busy channel, the scan can be set to pause, or to resume after a pause. (Except for a Repeater scan).

• See page 6 for details on the Scan Restart function.

◆ Selecting a scan type

- ➔ Push **[O-G-P RS]** several times to select the desired scan type.
 - Select Open, Group or Priority scan.

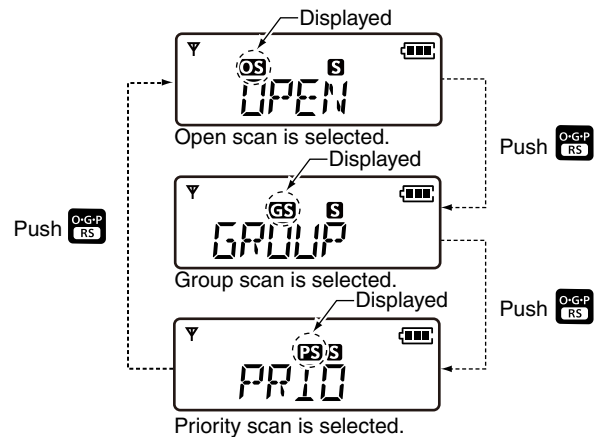

◆ Setting a Tag channel

Before setting tag channels, you must select the desired scan type, as described above.

NOTE: All channels for each scan type are tagged by default. To select the channels to scan, you must first untag the undesired channels.

- 1 Select the desired scan type.
- 2 Rotate [ROTARY SELECTOR] to select the undesired channel.
- 3 Hold down **[SCAN TAG]** for 2 seconds to untag the selected channel.
 - "S" disappears when the tag setting is OFF.

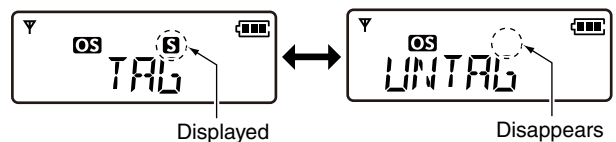

- 4 Repeat steps 1 to 3 until all the undesired channels are untagged.

To tag

- 1 Rotate [ROTARY SELECTOR] to select an untagged channel.
- 2 Hold down **[SCAN TAG]** for 2 seconds to tag the selected channel.
 - "S" is displayed when the selected channel is tagged.

Scanning preparation (Continued)

◇ Setting the Scan Stop Timer

- ① Hold down [TOP] for 2 seconds to enter the Set mode.
- ② Push [Side 1] or [Side 2] several times to select the Scan Stop Timer function.
 - “S-TIME” is displayed.
- ③ Rotate [ROTARY SELECTOR] to select the scan stop time.
 - 5/10/15:** Scan pauses for 5, 10 or 15 seconds when a signal is detected, then resumes.
 - P5:** Scan pauses until the signal disappears, and then resumes after 5 seconds (Recommended setting).
- ④ Hold down [TOP] for 2 seconds to set and exit the Set mode.

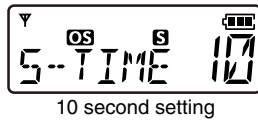
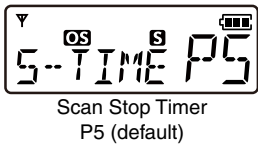

Open scan

An Open scan automatically searches for busy channels and enables you to locate new stations for communication or listening.

- ① Push [OS] several times until Open scan is selected.
 - “OS” is displayed.

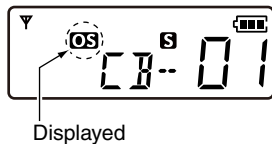

- ② Push [SCAN TAG] to start the scan.

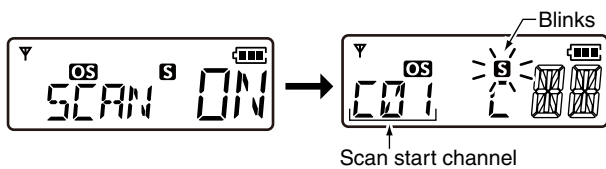

- ③ When receiving a signal, the scan pauses and resumes, according to the selected Scan Stop Timer setting.
- ④ Push [SCAN TAG] to cancel the scan.

Group and Priority scan

Group and Priority scans repeatedly searches for a signal on the Priority channel while scanning the tagged channels. This is useful when waiting for a call on the Priority channel or several tagged channels. Group and Priority scans are performed differently while transmitting. Group scan searches on a Priority channel or on a busy channel, and Priority scan searches only on the Priority channel.

- ① Push [G-P RS] until Group or Priority scan is selected.
 - “GS” is displayed when Group scan is selected, and “PS” is displayed when Priority scan is selected.

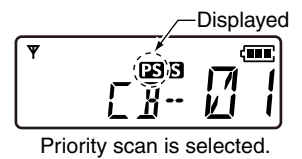
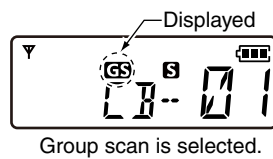

- ② If Priority scan is selected in step ①, set the Priority channel by holding down [PRIO SETUP] for 2 seconds after selecting the desired channel.
 - To cancel the Priority channel setting, push [TOP] to enter the Function mode, and then hold down [PRIO SETUP] for 2 seconds.



- ③ Push [SCAN TAG] to start the scan.

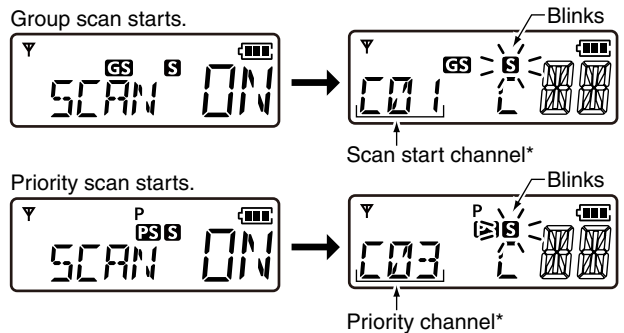

*Priority channel is displayed instead of the scan start channel if the Priority channel is set in step ②.

- ④ When receiving a signal, the scan pauses and then resumes according to the Scan Stop Timer setting.
- ⑤ Push [SCAN TAG] to cancel the scan.

Repeater scan

The Repeater scan is used not only to search for a signal on the repeater channels, but also to access a repeater by automatically transmitting in sequence. The Repeater scan detects repeaters that can be accessed in the area, even if the repeater is not used.

The Repeater scan detects signals only on channels 1 to 8 (channel 5 not included) and 41 to 48. The scan will stop if any activity is detected on a repeater channel, even if a repeater is not present. Activity such as stations operating in Simplex mode on a repeater transmit channel may give a false indication that a repeater is present.

- 1 Select the desired repeater channel and then hold down  for 2 seconds to start the Repeater scan.

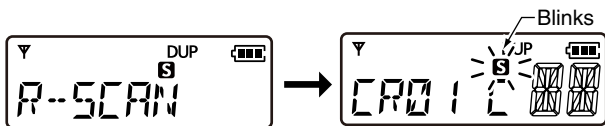

- 2 When a signal is received on a repeater channel, the scan stops.
 - After automatically transmitting, 3 high beeps sound when a signal is received, and 3 low beeps sound when no signal is received.
- 3 Push  to cancel the scan.
 - While transmitting, you cannot cancel the Repeater scan.

◇ Repeater scan flow

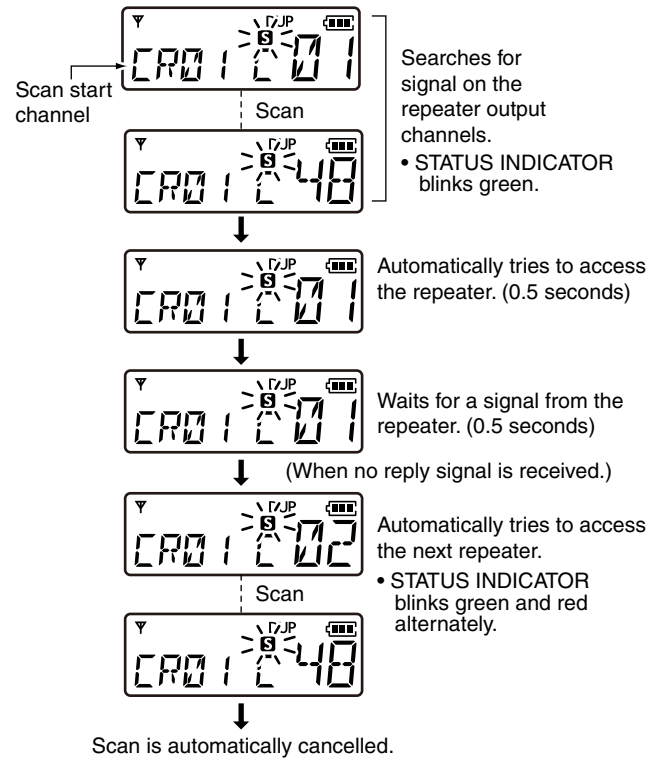

NOTE: Scan excludes the emergency repeater channel 05.

Tone Squelch

The transceiver is equipped with 51 CTCSS tone frequencies, and 104 DTCS codes. CTCSS/DTCS operation enables you to communicate in the silent standby mode, since you will only receive calls from group members using the same CTCSS tone frequency or DTCS code.

NOTE: Channels 5 and 35 are used for the emergency channels, and the CTCSS/DTCS function is not selectable on those channels.

Information

- Selectable CTCSS tone frequencies and DTCS codes are listed to the right.
- The transceiver has 51 tone frequencies and consequently their spacing is narrow compared to units having 38 tones. Therefore, some tone frequencies may receive interference from adjacent tone frequencies.

Setting the CTCSS tone frequency/DTCS code

- Hold down [TOP] for 2 seconds to enter the Set mode.
- Push [Side 1] or [Side 2] to select the CTCSS/DTCS menu.
- Push **SCAN TAG** to select between CTCSS and DTCS to enter the setting mode.

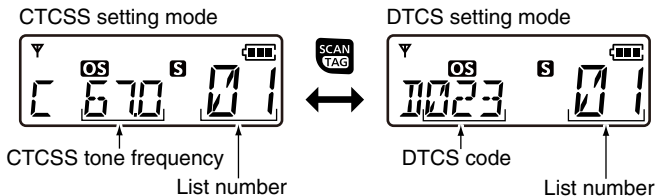

- "List number" is the number in the grey column in the table to the right.
- Rotate [ROTARY SELECTOR] to set the desired CTCSS tone frequency or DTCS code.
 - Hold down [TOP] for 2 seconds to save and exit the Set mode.

Selectable CTCSS tone frequency list (Hz)

No.	Freq.	No.	Freq.	No.	Freq.	No.	Freq.	No.	Freq.
01	67.0	12	94.8	23	136.5	34	177.3	45	218.1
02	69.3	13	97.4	24	141.3	35	179.9	46	225.7
03	71.0	14	100.0	25	146.2	36	183.5	47	229.1
04	71.9	15	103.5	26	151.4	37	186.2	48	233.6
05	74.4	16	107.2	27	156.7	38	189.9	49	241.8
06	77.0	17	110.9	28	159.8	39	192.8	50	250.3
07	79.7	18	114.8	29	162.2	40	196.6	51	254.1
08	82.5	19	118.8	30	165.5	41	199.5		
09	85.4	20	123.0	31	167.9	42	203.5		
10	88.5	21	127.3	32	171.3	43	206.5		
11	91.5	22	131.8	33	173.8	44	210.7		

Selectable DTCS code list

No.	Code	No.	Code	No.	Code	No.	Code	No.	Code
01	023	22	131	43	251	64	371	85	532
02	025	23	132	44	252	65	411	86	546
03	026	24	134	45	255	66	412	87	565
04	031	25	143	46	261	67	413	88	606
05	032	26	145	47	263	68	423	89	612
06	036	27	152	48	265	69	431	90	624
07	043	28	155	49	266	70	432	91	627
08	047	29	156	50	271	71	445	92	631
09	051	30	162	51	274	72	446	93	632
10	053	31	165	52	306	73	452	94	654
11	054	32	172	53	311	74	454	95	662
12	065	33	174	54	315	75	455	96	664
13	071	34	205	55	325	76	462	97	703
14	072	35	212	56	331	77	464	98	712
15	073	36	223	57	332	78	465	99	723
16	074	37	225	58	343	79	466	100	731
17	114	38	226	59	346	80	503	101	732
18	115	39	243	60	351	81	506	102	734
19	116	40	244	61	356	82	516	103	743
20	122	41	245	62	364	83	523	104	754
21	125	42	246	63	365	84	526		

Turning ON the Tone Squelch

Before turning ON the Tone Squelch, set the desired CTCSS tone frequency or DTCS code in the Set mode as described to the left.

- Rotate [ROTARY SELECTOR] to select the desired channel (excluding channel 5 or 35).
- Hold down [Side 1] for 2 seconds several times until "TSQL" is displayed.
 - Holding down [Side 1] for 2 seconds switches between "TSQL" (Tone Squelch), "TSQL (Pocket BEEP) and OFF (cancel).
 - When you receive a signal with a matching tone or code, the squelch opens, and you can hear the signal. When you receive a signal that does not match, the squelch does not open.

Pocket Beep

This function uses the CTCSS (subaudible) tone and the DTCS code for calling. You can also use it as a “common pager” to inform you that someone called while you were away from the transceiver.

◇ Waiting for a call from a station

- ① Rotate [ROTARY SELECTOR] to select the desired channel (excluding channel 5 or 35).
- ② Hold down [Side 1] for 2 seconds several times until “TSQL 📞” is displayed.
 - Holding down [Side 1] for 2 seconds switches between “TSQL” (Tone Squelch), “TSQL 📞” (Pocket Beep) and OFF (cancel).
 - When you receive a signal with a matching tone or code, a beep sounds every 10 seconds and “📞” blinks.

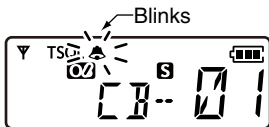

- ③ Push [PTT] to answer and to stop the beep and blinking.
 - The transceiver automatically selects Tone Squelch.

Section 6 SELCALL (Selective Calling)

Besides the Tone Squelch function for silent standby, you can use the Selcall (Selective Calling) function. Selcall has 100,000 options when using 5 tone. You can use the Selcall function to call another unit or calling a Group on the same channel, as well as station code, text, the answer back function and auto scan start. These, and many more, can be set using the optional CS-41PRO CLONING SOFTWARE.

- NOTE:**
- Channels 5 and 35 are the emergency channels, and Selcall cannot be used on these channels.
 - A Selcall transmission is restricted to a total of 3 seconds in a 1 minute period.

Calling

TX code is the Selcall code that you transmit. A maximum of 32 TX codes can be entered into the IC-41PRO, using the optional CS-41PRO CLONING SOFTWARE.

◇ Selecting a TX code

- ① Select the desired CB channel, except for channels 5 and 35.
- ② Push [TOP] to enter the Function mode, and then push  to enter the TX code selection mode.
 - If entered using the CS-41PRO CLONING SOFTWARE, the text is displayed instead of the code.

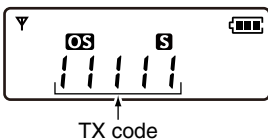



- ③ Rotate [ROTARY SELECTOR] to select the desired TX code or text.
- ④ Push [PTT] to transmit the selected TX code, or push  to set the selected TX code and return to the standby mode.
 - When you transmit, a short beep sounds.

Information

TX code texts can be assigned to all the 32 TX codes using the CS-41PRO CLONING SOFTWARE.

◇ Editing the TX code

You can edit the TX code within the allowed digits. The Group call function enables you to edit a special “Group code” of the Selcall ID code.

- ① Select the desired CB channel, except for channels 5 and 35.
- ② Push [TOP] to enter the Function mode, and then push  to enter the TX code selection mode.
- ③ Hold down  for 2 seconds to enter the TX code editing mode.

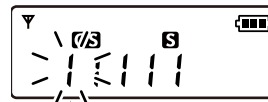

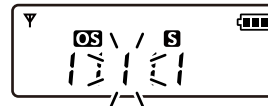

The editing digit starts blinking

- ④ Push  to select the editing digit.

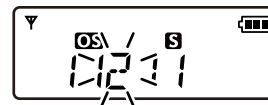

- ⑤ Rotate [ROTARY SELECTOR] to set the desired number.



- ⑥ Repeat steps ④ and ⑤ to enter other digits.
- ⑦ After editing, push  to set the code and return to the TX code selection mode.
- ⑧ Push [PTT] to transmit the selected TX code, or push  to save the edited TX code and return to the standby mode.
 - When you transmit, a short beep sounds.

NOTE: The TX code digits that can be edited by the user are set using the CS-41PRO CLONING SOFTWARE.

◇ Transmitting an individual Selcall

- ① Push [TOP] to enter the Function mode, and then push  to enter the TX code selection mode.
- ② Rotate [ROTARY SELECTOR] to select the desired TX code.
- ③ Push [PTT] to transmit an individual call.
 - A short beep sounds.

Receiving

◆ Receiving an individual Selcall

- ① When receiving an RX code:
 - Beeps sound.
 - The RX code's text is displayed, if entered.
 - "🔔" blinks and the channel name is displayed, and the Selcall mute is released.
- ② Hold down [PTT] and speak at your normal voice level.

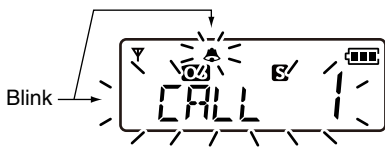

NOTE:

- If the ID decode function "ID Dec" is turned ON, the received Own ID code is displayed instead of the text, and memorised into the transceiver. This function can be turned ON using the CS-41PRO CLONING SOFTWARE.
- A maximum of 8 individual RX codes can be memorised into the transceiver, using the CS-41PRO CLONING SOFTWARE.

◆ Recalling a memorised RX code

- ① Push [TOP] to enter the Function mode, and then hold down [OS] for 2 seconds to display the memorised RX code.
- ② Rotate [ROTARY SELECTOR] to select the desired RX code.
- ③ Hold down [PTT] to transmit to the selected code.

NOTE: When a 6th RX code is received, the oldest code is deleted from the transceiver.

◆ Receiving a Group call

- ① When receiving a Group call:
 - Beeps sound.
 - "🔔" and "GROUP" blink, and the Selcall mute is released.
- ② Hold down [PTT] and speak at your normal voice level.

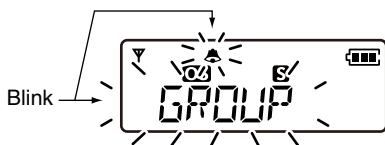

- You can set the Group call receiving options using the optional CS-41PRO CLONING SOFTWARE. Consult the CS-41PRO help file for more information.

Quiet Mode

When the Quiet mode is ON, the Selcall mute function is activated and enables silent operation until a Selcall code is received.

- ① Push [TOP] to enter the Function mode.
- ② Push [OS] to turn the Quiet mode ON or OFF.
 - "Q" is displayed when the Quiet mode is ON.

To monitor the channel:

- Push [Side 1] to release the mute.
 - A beep sounds.

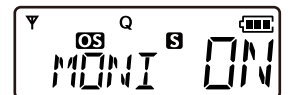

To enable the Selcall mute:

- Push [Side 1] to enable the mute.
 - A beep sounds.

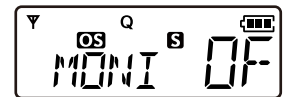

NOTE: The unmute mode may automatically return to the mute mode after a specified time period, depending on the presetting.

Stun function

This function can only be set by your dealer. If the transceiver is in the Stun mode, it will request a password when you turn ON the transceiver. This password is the same as the Power ON password. Once the password has been entered, the transceiver will not prompt you to enter it again.

Cloning and transceiver operations are disabled after a Kill ID is received. By activating the clone write mode, you can use the transceiver again. (The internal data cannot be accessed using the Clone Read mode.)

Section 7 OTHER FUNCTIONS

Smart Ring and ATS (Automatic Transponder System)

The Smart Ring and ATS functions have an answer back feature and confirmation function for when a call has reached the called station, even if the user is temporarily away from the transceiver. Smart Ring is a manual confirmation, and ATS is automatic.

Smart Ring

- ① Set the same CTCSS tone frequency to all the transceivers in the group, and then turn ON the Tone Squelch. (p. 11)
- ② Push [TOP] to enter the Function mode.
- ③ Push **PRG** to send a Smart Ring call.
 - When a member of the group answers the call, “**FOUND**” blink.
 - If no answer is received, the transceiver sounds short failure beeps and “**FAILED**” appears.

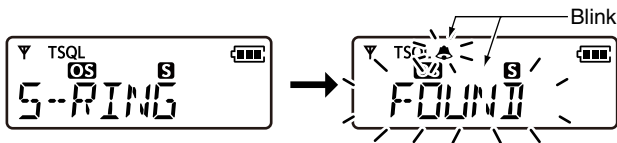

- ④ Push [PTT] to answer and to stop the blinking and the beeps.

NOTE: The Smart Ring function can be used only if the called station has the same CTCSS tone frequency and is operating on the same channel.

NOTE: The setting to the left is for only the calling station. A called station automatically sends an answer back signal without any presetting. All the IC-41PROs set to the same operating channel within the communication area will send an answer back call.

ATS

- ① Hold down [Side 2] for 2 seconds to turn ON the ATS function.
 - When an RX channel is selected, an error beep sounds.
 - The transceiver automatically sends a searching signal every 60 seconds.
 - “**▽**” blinks.
 - When you receive an answer back signal, “**▽**” stops blinking until the next search transmission.
 - If no reply is received, “**▽**” blinks until the next search transmission.

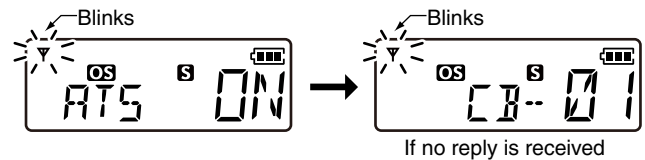

- ② Hold down [Side 2] for 2 seconds to turn OFF the ATS function.

RX channels and frequencies

You can enable the use of the RX channels on the transceiver screen using the optional CS-41PRO CLONING SOFTWARE. RX channels are not displayed as the default. Also, you can edit the RX frequencies between 450 through 520 MHz using the CS-41PRO or using the transceiver if the RX channels have been enabled.

Editing an RX frequency

- ① Select the desired RX channel (Example: RX-01).
- ② Push [TOP] to enter the Function mode, and then hold down [TOP] for 2 seconds to enter the RX VFO mode.
 - Push **LOW** to select the wide or narrow channel spacing.

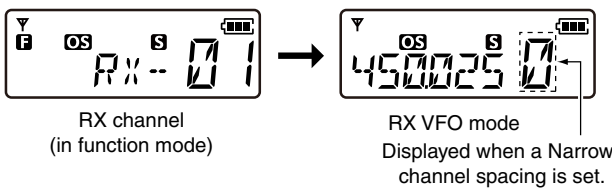

- ③ Rotate [ROTARY SELECTOR] to select the desired RX frequency. The frequency selection scrolls according to the bandwidth setting.

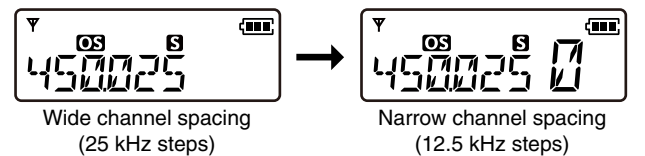

- ④ Push **SCAN** to select the editing digit.
 - The editing digit blinks.

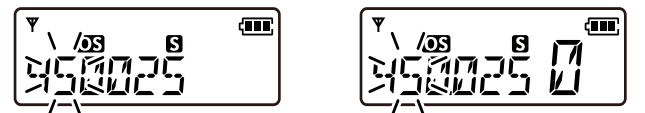

- ⑤ Rotate [ROTARY SELECTOR] to set the desired number to the digit.

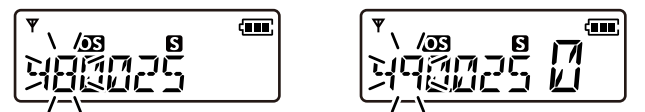

- ⑥ Repeat steps ④ and ⑤ to edit the RX frequency.
- ⑦ Hold down [TOP] for 2 seconds to save the RX frequency and return to the standby mode.
 - Two beeps sound.

PTT Hold

You can use the PTT switch as a one-touch PTT switch (each push switches between transmit and receive). You can transmit without holding down [PTT] using this function. To prevent accidental continuous transmission with this function, transmission automatically stops after 3 minutes.

- ① Hold down [TOP] for 2 seconds to enter the Set mode.
- ② Push [Side 1] several times to select the PTT Hold function item.
- ③ Rotate [ROTARY SELECTOR] to turn ON the PTT Hold function.

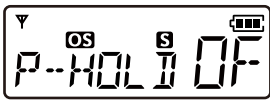

PTT Hold function
OFF (default)

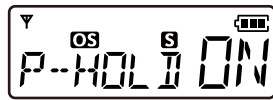

PTT Hold function ON

- ④ Hold down [TOP] for 2 seconds to set and return to the standby mode.
- ⑤ Push [PTT] to transmit, and push again to return to receive.
 - STATUS INDICATOR lights red while transmitting.

NOTE: You cannot use the PTT Hold function with an optional microphone connected. The PTT Hold function setting is invalid on the optional microphone.

Data cloning

Data cloning enables you to transfer data quickly and easily from a PC to your transceiver, using the optional CS-41PRO CLONING SOFTWARE.

Data cloning can be done to or from a PC, using the CS-41PRO CLONING SOFTWARE and the optional OPC-478UC (USB type) CLONING CABLE.

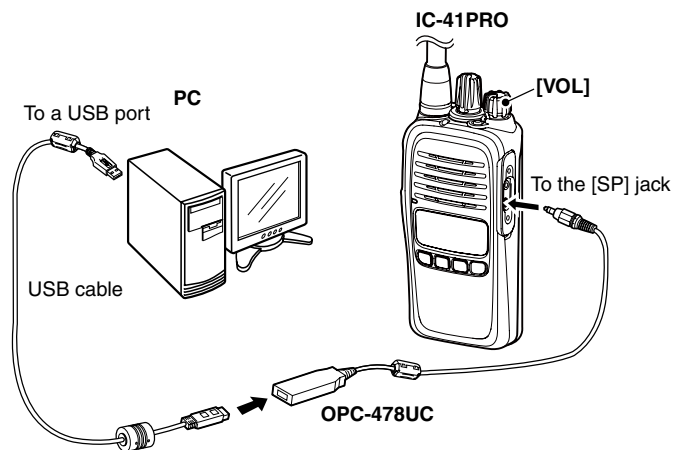

Section 8 SPECIFICATIONS

◇ General

- Frequency coverage:
 - AUS CB 476.4250–477.4125 MHz
 - Private/RX only 450.000 –520.000 MHz
- Type of emission:
 - AUS CB W: 16K0F3E (25.0 kHz)
N: 8K50F3E (12.5 kHz)
- Channel spacing:
 - AUS CB 12.5 kHz
 - Private/RX only 12.5/25 kHz
- Current drain (at 7.5 V):
 - TX High (at 5 W) 1.7 A
 - RX maximum audio 500 mA
- Power supply requirement: 7.5 V DC nominal* (Negative ground)
*Specified Icom's battery pack only
- Frequency stability: ±2.5 ppm (–30°C to + 60°C)
- Antenna impedance: 50 Ω nominal
- Dimensions: W 52.2 × H 111.8 × D 30.3 mm
(Projections not included)
- Weight: Approximately 270 g (with BP-280)

◇ Transmitter

- Output power: 5 W
- Modulation system: Variable reactance frequency modulation
- Maximum permissible deviation: W: ±5.0 kHz
N: ±2.5 kHz
- Spurious emissions:
 - #31,32,33,50,54,55 70 dB (min)
 - #71,72,73 63 dB (min)

◇ Receiver

- Receive system: Double conversion superheterodyne
- Sensitivity (12 dB SINAD):
 - #31,32,33,50,54,55 0.25 μV (typical)
 - #71,72,73 0.2 μV (typical)
- Squelch sensitivity: 0.25 μV (typical)
- Intermodulation:
 - #31,32,33,50,54,55 70 dB (min) 73 dB (typical)
 - #71,72,73 60 dB (min) 65 dB (typical)
- Spurious response:
 - #31,32,33,50,54,55 70 dB (min)
 - #71,72,73 60 dB (min)
- Audio output power: 1.5 W (typical) at 5% distortion with 8 Ω load (INT)
0.4 W (typical) at 5% distortion with 8 Ω load (EXT)

All stated specifications are subject to change without notice or obligation.

INDEX

A		R	
ATS (Automatic Transponder System)	15	Receiving, Selcall	14
Auto Power OFF	5	Repeater, accessing	7
B		Repeater operation	7
Backlight	4	Ringer Level	5
Battery Voltage	5	Roger Beep	5
Beep	4	RX channels	15
Beep Level	4	RX frequencies	15
C		RX frequency, editing	15
Call from a station, waiting	12	S	
Channel Announce	4	Scan, Group and Priority	9
Channel selection	1	Scanning preparation	8
CTCSS	4	Scan, Open	9
CTCSS tone frequency list	11	Scan, Repeater	10
CTCSS tone frequency, setting	11	Scan, Repeater scan flow	10
D		Scan Restart	6
Data cloning	16	Scan Stop Timer	6
DTCS.....	4	Scan Stop Timer, setting	9
DTCS code list	11	Scan types	8
DTCS code, setting	11	Scan type, selecting	8
G		Selcall, receiving (individual)	14
Group call, receiving	14	Selcall mute, enabling	14
I		Selcall, transmitting (individual)	13
Individual Selcall, receiving	14	Set mode sequence	3
Individual Selcall, transmitting	13	Signal Monitor	5
K		Smart Ring	15
Keylock	1	Specifications	17
Keys, lock	1	Squelch	2
Keys, non-locked	1	Squelch Level	5
keys, unlock	1	Squelch level, setting	2
L		Stun function	14
Lockout	6	T	
M		Tag channel, setting	8
Memorised RX code, recalling	14	Tone Squelch	11
Mic Gain	5	Tone Squelch, turning ON	11
Monitor	2	TX code, editing	13
O		TX code, selecting	13
Own ID	3, 6	V	
Own ID, editing	6	VOX	4
P		VOX Delay (Sec)	4
Pocket Beep	12	VOX Gain	4
Power Save	5	VOX related items	3
Priority channel	2	Z	
Priority channel, cancelling	2	Zone selection	2
Priority channel, setting	2		
Priority channel, switching	2		
PTT Hold	6, 16		
PWR ON Password	1		
Q			
Quiet Mode	14		

